



TILSATEC®

High Performance Hand, Arm & Body Protection Product Catalogue

2018/
2019





PERFORMANCE



E IN EVERY FIBRE

MADE IN GREAT BRITAIN
SANDERSON & CO
LIMITED LONDON

CONTENTS

Cut Resistant Specialists	5
Hand Protection Evaluation Process	6
PPE Regulation (EU) 2016/425	7
EN Standards Explained	8-9
Tilsatec Mechanical Testing Laboratory	10-11
Rhino Yarn™ Technology	12
UK Manufacturing Expansion	12
Materials Guide	13
Sleeve Styles	13
Lightweight Coated Cut Range	14-19
Medium Weight Coated Cut Range	20-25
Rhinoguard™ Cut Puncture and Needlestick Protection	26-27
Food Safe Cut Range	28-29
Knitted and Leather Range	30-35
Arm and Body Protection	36-39

Cut resistant specialists

Tilsatec is a UK manufacturer with a long history in developing technical yarns and materials for PPE. Specialising in cut resistant hand and arm protection we are able to engineer high levels of performance and mechanical protection into all our products. Working closely in partnership with customers, we design and develop solutions from the ground up to ensure they are receiving maximum performance/cost efficiencies.

For businesses who want expertise they can rely on to keep their people safe, Tilsatec deliver high performance hand, arm and body protection solutions. We manufacture our own proprietary cut resistant yarn - the primary source of mechanical protection, on site in the UK. This means we can deliver maximum performance in every fibre of what we do. Because when our gloves perform at their best, your people can perform at their best.

Selecting the right protective solution for your needs is vital, but can sometimes seem a complex exercise. Our representatives are able to guide you through the entire process, this typically includes conducting a comprehensive hand protection site survey to understand the hazards and requirements involved. They can then make clear and simple recommendations as to the type and style of PPE you need. Following successful trials, they can also assist with on site training and inductions to ensure workers are wearing and using their PPE correctly from the outset, ensuring they go home safely at the end of the day.

This catalogue is a guide to our current range of PPE solutions, but if you have a particular requirement in mind that you can't see here you can contact us at info@tilsatec.com and we'd be happy to discuss a bespoke solution tailored to your exacting needs.



The **British Safety Industry Federation (BSiF)** is the lead association for the Personal Protective Equipment (PPE) Directive and is recognised as a Competent Authority by the Health & Safety Executive (HSE). The BSiF has active links with many government departments and over 130 representative Trade Bodies.

Set up in 1994, the Federation currently has some 160 members, ranging from manufacturers and distributors of safety products through to test houses, certification bodies and safety professionals.

Today the BSiF is firmly established as the major independent voice of the British safety industry, helping to both influence legislation and provide industry in general with a source of authoritative information on a range of workplace safety issues, while representing the needs of its members.

Tilsatec are members of the BSiF and also a **Registered Safety Supplier**. The purpose of this scheme is to provide a signposting service for employers to help them purchase 'safe' products and eliminate counterfeit, unsafe and illegal safety products from the market. So when you buy PPE from Tilsatec you can be assured it is compliant and approved to industry legislation and regulation. Find out more about BSiF and what they do: www.bsif.co.uk



Tilsatec are members of the **North East Automotive Alliance (NEAA)**, an industry-led cluster group, established to support the economic sustainable growth and competitiveness of the sector in the North East of England. With over 230 participants, the NEAA is the largest automotive cluster in the UK and one of the fastest growing clusters across Europe.

The NEAA provides a single unified voice to key stakeholder groups and promotes the true value created by the North East Automotive sector. There are over 240 automotive companies in the NE automotive sector, together they generate over £11 billion in sales, export over £6.5 billion annually, with a trade surplus of £2.6bn. Today the sector directly employs 30,000 people, impacts a further 141,000 jobs across the UK, and we are proud to be an approved supplier to many automotive OEM's and tier 1 and tier 2 supply chain companies and manufacturers in the North East region.

Hand protection evaluation process

When it comes to identifying and specifying the right hand protection for your work force, it can seem overwhelming looking at the number of protective gloves now in the market place.

Our Hand Protection Evaluation process is simple, clear, tried and tested, designed to guide you every step of the way and support you beyond your initial selection stage.

With their specialist expertise in high level cut resistance our Sales Team can provide you with the following support and assistance:

- Conduct a site survey to assess all handling hazards and requirements
- Provide an end user report with product recommendations for every department
- Set up on site trialling and sampling to ensure gloves are tested thoroughly
- Monitor and assess glove trials
- Deliver product training to staff and distributors
- Provide educational infographics and posters to encourage best practice in hand protection
- Carry out ongoing sales support and site visits

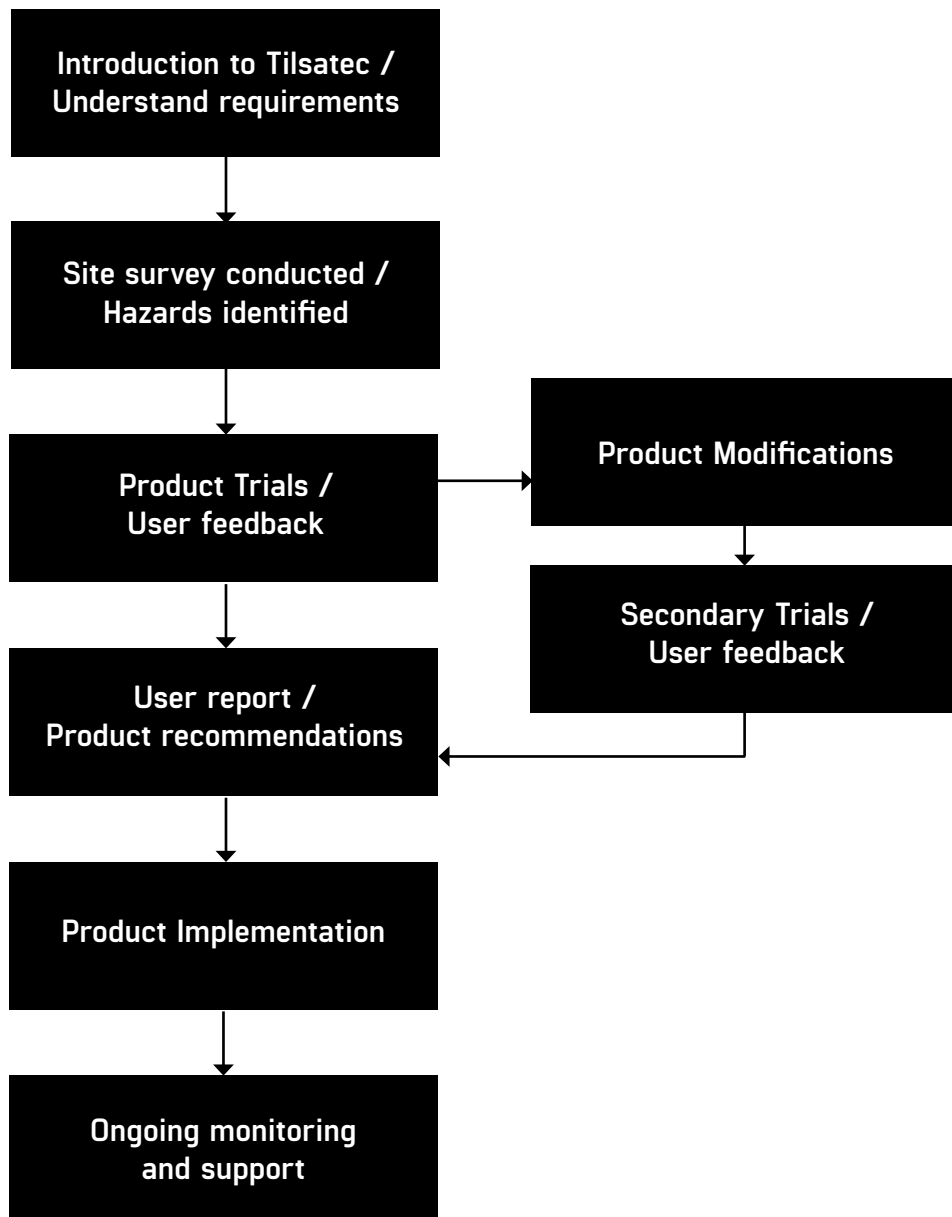

To find out about how the Hand Protection Evaluation Process can benefit your business or to request a free site survey contact trialrequest@tilsatec.com and the team will be happy to help get you started.

PPE Regulation (EU) 2016/425

On February 12th 2016 the new PPE Regulation (EU) 2016/425 was finalised and will be formally adopted as of April 21st 2018. There will however, be a one year transition period until April 2019.

Why the need for change?

- The PPE Directive is now over 20 years old
- It needs to reflect new technologies and developments in product design
- Current Directive is only applicable to EU Member States, the new Regulation will apply to all EU citizens
- It is currently transposed into each Member State's national law and therefore governed by each country differently
- The new Regulation is a binding legislative act applied in its entirety across the EU

What are the main changes?

- Bespoke items of PPE are now included in the regulation
- An EC Declaration of Conformity must be available with every item of PPE or a link provided to where it can be obtained
- Manufacturers are required to put their name and address on the item of PPE (with the exception of gloves due to size of product) and also within the EC DOC
- The responsibilities of both manufacturers and importers are clearly outlined
- A copy of the product risk assessment must be included with the technical file submitted for certification
- An EU examination certificate will be issued with a compulsory five year validity. If the item of PPE does not change, manufacturers will only be required to re-certify products up to 12 months before the expiry date of the certificate

The new directive specifies three classes of PPE based on the following categories of risk:

Category I: Simple PPE

Gloves and sleeves designed to protect against minimal risks such as superficial mechanical injury and cleaning. Manufacturers are permitted to test and self certify products.

Category II: Intermediate PPE

Hand and arm protection designed to protect against cuts, abrasion, puncture and tearing. This category of products must undergo independent testing and attain certification by an accredited notified body. A CE mark will then be issued by the notified body. No item of PPE can be sold or used in the EU without being issued a CE mark. The name and address of the notified body that issued the CE mark must be present on the Instructions for Use supplied with the product. Ongoing surveillance of performance must be carried out through testing.

Category III: Complex PPE

PPE in this category includes risks that may cause very serious consequences such as death or irreversible damage to health e.g. chemicals, harmful biological agents, extreme temperatures and cuts by hand-held chainsaws. PPE must undergo independent testing and certification the same as Category II products. The quality assurance system used by the manufacturer must also be independently checked and the identification number of the notified body should appear alongside the CE mark on the Instructions for Use. Ongoing surveillance of performance and manufacturing processes must be carried out through product testing and conducting factory audits.



Time line of key dates for regulation transition

Regulation adopted 12 Feb 2016	Regulation listed	Regulation Applies	All EC-Type certificates to PPED invalid
April 2016		April 2018	2023
Regulation published	Two year transition		Gloves certified to new PPE Regulation
	EC Certificates can be issued to old PPE Directive		
EC-Type Certificates to old PPE Directive remain valid until 2023 unless they expire before that date			

Between April 2018 and April 2019 manufacturers can supply products within the EU certified to both the Directive and the Regulation. From April 2019 new products can only be placed on the market certified to the new Regulation.

EN standards explained

EN420: 2003 - General requirements for protective gloves

Defines the general requirements for most types of protective gloves which includes:

- Glove construction
- Ergonomy
- Dexterity
- Innocuousness
- Product marking and packaging information
- Sizing
- Water vapour transmission and absorption
- Electrostatic properties

Sizing of gloves according to hand length and circumference:

Glove Size	Hand Circumference (mm)	Hand Length (mm)	Min length of glove (mm)
6	152	160	220
7	178	171	230
8	203	182	240
9	229	192	250
10	254	204	260
11	279	215	270

This pictogram indicates that the user should always consult the instructions for use:



EN388: 2016 - Mechanical Protection

In November 2016 the EN388 standard was updated to EN388:2016. The new pictogram can now report up to six different measurements of mechanical protection, including the new ISO 13997 cut resistance test data for products delivering high level cut protection or those which have demonstrated dulling of the blade using the original Blade Cut Test (represented as **b** the pictogram below).

Performance Level	1	2	3	4	5
Abrasion Resistance (cycles)	100	500	2000	8000	n/a
Blade Cut Resistance (index)	1.2	2.5	5.0	10.0	20.0
Tear Resistance (newtons)	10	25	50	75	n/a
Puncture Resistance (newtons)	20	60	100	150	n/a

Performance Level	a	b	c	d	e	f
ISO13997 Cut Resistance (newtons)	2	5	10	15	22	30
Impact Protection	PASS (P) or FAIL (no marking)					

Gloves which have not been tested under the Blade Cut test (b) will have a letter 'X' shown to indicate not tested or not applicable and only results from the ISO 13997 cut test (e) will be displayed as shown in the glove markings below.

For more information on the ISO cut test as part of the EN388: 2016 update visit: tilsatec.com/gb/news/changes-to-international-standards

EN 388: 2016

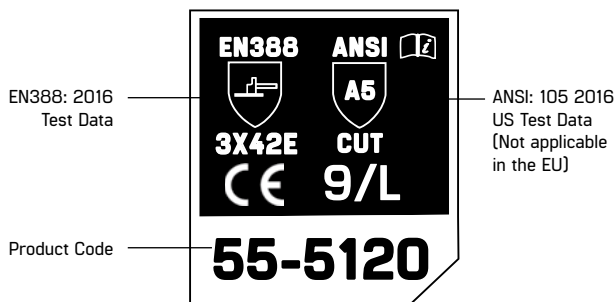
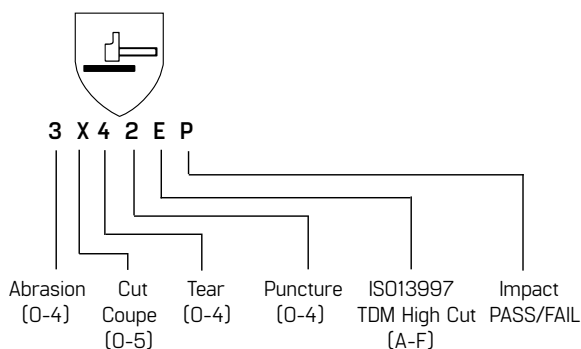

EN388:2016 Impact Protection

The impact test is a new optional addition to the EN388 standard, designed for gloves that provide impact resistance (usually to the back of the hand and knuckles). Gloves are tested to EN 13594:2015 Protective Gloves for Motorcycle Riders. Where gloves have passed the test the letter 'P' will be displayed (under f).

EN407: 2004 - Protection from Thermal Hazards

The heat and flame pictogram is shown with six numbers, representing performance levels against specific thermal hazard tests.



a b c d e f

a. Burning Behaviour	After flame time	< 20 s	< 10 s	< 3 s	< 2 s
	After glow time	no requir.	< 120 s	< 25 s	< 5 s
b. Contact Heat	Contact temperature	100°C	250°C	350°C	500°C
	Threshold time	> 15 s	> 15 s	> 15 s	> 15 s
c. Convective heat (heat transfer delay)		> 4 s	> 7 s	> 10 s	> 18 s
d. Radiant heat (heat transfer delay)		> 7 s	> 20 s	> 50 s	> 95 s
e. Small drops molten metal (# drops)		> 10	> 15	> 25	> 35
f. Large quantity molten metal (mass)		30g	60g	120g	200g

Needlestick Resistance

Resistance to punctures from needlestick is measured in Newtons according to ASTM F2878:10 which uses a 25 gauge hypodermic medical grade needle.

EN1149 Antistatic

EN 1149-5: 2008 is a European Standard which specifies the performance and design requirements for electrostatic dissipative clothing, used as part of an earthed clothing system to avoid the build up of static charges. There are a number of important applications where the use of antistatic hand protection is of critical importance, such as:

- To prevent charge build up and release in flammable atmospheric environments where there is a risk of incendiary discharge
- To avoid damage to sensitive electronic componentry during assembly processes
- To control the attraction of dust and other contaminants to critical pre-painted surfaces

Two different test methods exist for the characterisation of antistatic performance according to EN 1149-5.

EN 1149-1: Test method for measurement of surface resistivity

A specimen is placed on an insulating base plate and an electrode assembly placed on top. A Direct Current (DC) potential is applied and the resistance of the fabric is measured. This test determines the resistance over a short distance and is most appropriate for materials for which the electrostatic behaviour is based on surface conductivity. Materials must record $< 2.5 \times 10^{(9)}$ ohms to meet the requirements of the standard.

EN 1149-3: Test method for measurement of charge decay

A specimen is charged by an induction effect. The induced charge on the test material influences the field that is observed by a probe positioned above the test surface. The decrease in field charge is used to determine the half decay time and the shielding factor of the material. A half decay time of < 4 seconds or shielding factor of > 0.2 are required to meet the conditions of EN1149-5 using this test method.

EC Food Regulations

Tilsatec food range products are approved for contact with all foodstuffs in compliance with the parent directive 1935/2004/EC. They also comply with the specific requirements laid down in the Commission Regulation (EU) No 10/2011 plastic materials and articles intended to come into contact with food.

The regulation governs the substances that may be used in the manufacture of food contact materials (including gloves for food handling) and specify that under normal foreseeable conditions of use, they do not transfer their constituents to food in quantities which could:

- endanger human health; or
- bring about an unacceptable change in the composition of the food; or
- bring about a deterioration in the organoleptic characteristics (i.e texture, taste, aroma)

To ensure food contact materials comply with these regulations a series of test standards are applied (EN 1186) to determine migration levels from contact materials into the food using a variety of food simulants.

Compliance with the allowable limits enables food gloves to be marked with the following 'food safe' pictogram:



Tilsatec food approved products have been tested according to these standards and meet the total extractive and overall migration limits required for repeat use application.

Tilsatec mechanical testing laboratory

Services and expertise

- Compliance monitoring and compilation of CE certificate applications
- Performance and quality control testing of raw materials, yarns and finished products
- Supporting of new product development
- Ongoing due diligence product testing
- Bespoke in house testing to suit customer's specific hazards/requirements
- Benchmark testing to ensure test results are in line with industry standards

Assurance. Reliability. Accuracy. Consistency.



These are the values which we strive to provide to customers in our products, people, manufacturing and testing. If we believe a current EN standard doesn't go far enough in providing customers with the performance data they need, we will develop unique in house test methods which go beyond the standard to give more realistic data, representative of real life working conditions and hazards.



Technical support and product guidance

Alongside our experienced sales representatives, the technical team can provide additional advice and support on the suitability of a product and make recommendations on factors such as cut resistance, grip performance, abrasion, liquid repellency, thermal properties and breathability.

Where a customer may have concerns as to the suitability of a product for their particular application, the laboratory team can assist in evaluating the nature of the tasks being performed and provide a detailed evaluation.



EN388: 2016 Blade Cut Resistance

- Tilsatec is one of only a small number of testing laboratories in the UK to use a TDM-100 machine to conduct cut resistance testing to EN ISO 13997:2009.
- International testing can be performed to the ANSI/ISEA:105-16 standard according to the test method ASTM F2992-15.
- The TDM-100 has been designed to allow laboratories to test in excess of 100 Newtons of force. This is necessary for the achievement of greater accuracy in results when testing highly cut resistant materials.
- The ISO 13997:1999 test method uses a straight edge blade drawn across the sample in one direction. The blade is replaced after each cut has been performed.
- A range of loads are used throughout the test and the cutting distance against the force used (in Newtons) is plotted to determine the force required to cut through the material in a 20mm blade stroke.



ASTM F2878-10 Hypodermic Needle Puncture Testing

- Ability to test high performance hypodermic needle puncture resistant materials using calibrated 25, 23 or 21g needles.
- A tensometer is used to drive the needle through the material to simulate real life puncture hazards as closely as possible.
- A minimum of 12 samples are tested and the mean is determined to give an accurate force required to puncture the material.
- **EN388:2016 Puncture Resistance**
 - A larger 4mm probe with rounded stylus is pressed at force 50mm into the material at a speed of 100mm/min. The test is carried out on 4 specimens where the highest value of force is recorded. The final result is the lowest obtained value and determines the puncture score that is given between levels 1-4.
- **EN388:2016 Tear Resistance**
 - Four samples are tested for tearing force using a tensometer. Two rectangular specimens with a 50mm slit in the longitudinal direction are taken across the palm of 2 separate gloves, and two specimens are taken along the length of 2 separate gloves. The highest tearing force for each specimen is recorded and a classification level of 1-4 is determined by taking the lowest of the four results achieved.



EN388:2016 Abrasion Resistance Testing

- The Martindale Abrasion Tester is the Internationally accepted equipment for testing abrasion and wearing of fabrics.
- The M235 used in the Tilsatec laboratory is the very latest model ensuring accurate readings that provide consistent results.
- EN388:2016 Resistance to Abrasion is performed by rubbing circular glove specimens against the specified grit paper under a force of 9 kilopascals in a lissajous pattern.
- Abrasion is determined by observation of the specimen after a number of rubs defined by the performance level. Failure is observed once complete breakthrough of the sample is reached.
- High performance materials can be tested to in excess of 8000 cycles until degradation of the sample is visible.



Product Analysis, Evaluation and Compliance

- General requirements for EN420 are all analysed these include sizing, dexterity and pH testing.
- Food migration testing is performed to ensure gloves carrying the food safe pictogram comply with the current EU Directive for food contact under the test methods within EN1186.
- In-house development of innovative test methods to closer replicate real working conditions and hazards.
- An indicative contact heat test has been developed to determine additional thermal properties of materials that are not included within the current standard test methods.
- Friction testing to analyse the gripping properties of different materials in a number of conditions.



Whenever you see the Rhino Yarn™ mark it means a product has been made using our own yarn technology. With this comes the assurance of full quality control, processing traceability and mechanical performance efficiencies built in at every level.

How does it work?

Rhino Yarn™ technology is an engineered yarn process which combines various technical fibres and materials. Such materials can be used on their own, but when blended together to create a composite yarn, can achieve significantly higher levels of cut protection, without compromising on comfort or dexterity.



Each component is carefully selected to engineer a product which delivers the desired mechanical performance in the most efficient and value driven structure possible.

Manufactured on site by a dedicated team of yarn technologists, Tilsatec are able to design bespoke developments to meet customers' exacting needs in a wide range of industries.

Backed up by 135 years of experience in yarn and textile manufacturing, an extensive R&D facility and more recently investment in a comprehensive glove testing laboratory, Tilsatec is well placed to meet the rapidly changing and diverse hand and arm protection needs of industry, today and in the future.

UK manufacturing expansion

Retaining UK manufacture of the Rhino Yarn™ technology is a hugely important objective for Tilsatec. Our experienced workforce are specialists in yarn spinning and production, able to continually push the boundaries of what is possible in yarn construction. It is this that differentiates Tilsatec products in the market place and it is hugely important we retain this UK based provenance for our customers.

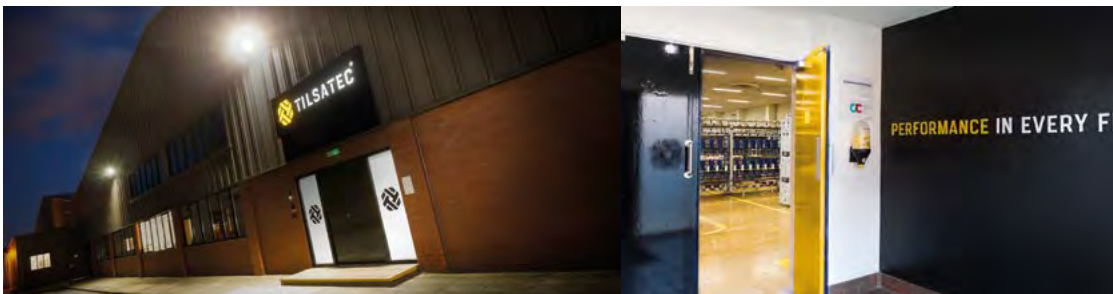

With this in mind, significant investment has been made in expanding our UK head office operations to include a new PPE manufacturing facility. The new unit will enable rapid prototyping and wider scope for new product development whilst allowing for a much quicker turn around time for trials and sample orders.

It will also have the capability to make product modifications and additions, allowing customers to test a wider number of solutions ensuring the right product is implemented. Tilsatec are inviting customers and partners to tour the new manufacturing facility and testing laboratory throughout 2018. To arrange a visit you can contact your representative or email: info@tilsatec.com and tel: 01924 375742.

Materials guide

Every glove in the Tilsatec range is designed combining the most suitable liner construction, coating, cuff and finish to deliver the optimum fit, wear and level of protection to ensure end users have the most appropriate hand protection for their needs. Below are just some of the commonly found characteristics/materials found in the Tilsatec range.

Coatings



Micropore foam nitrile

Tough and durable it offers high abrasion resistance and oil grip.

Applications: auto industry, metal fabrication, engineering, oily applications.

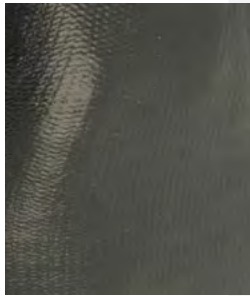

Flat nitrile

Tough and durable it offers high abrasion resistance and oil grip.

Applications: auto industry, metal fabrication, engineering, oily applications.

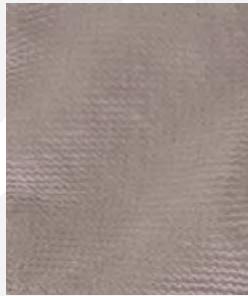

Polyurethane (PU)

Provides good dry grip and dexterity, ideal for light weight gloves.

Applications: assembly, small parts, material handling.



Natural Rubber Latex

Delivers high puncture resistance and good for liquid protection and grip.

Applications: waste handling, outdoors work, construction and glass manufacturing.



Dot Pattern

Dot patterns to the palm provide enhanced grip.

Applications: warehousing, paper industry, distribution, and general handling.

Cuff styles



Knitwrist



Safety Cuff



Neoprene

Glove construction

Seamless Knitted: The majority of gloves in the Tilsatec Rhino and General Purpose Hand Protection ranges are a seamless knitted liner constructed from our Rhino cut resistant yarn or a natural yarn fibre. Seamless knitting provides a better fit and eliminates seams which can be uncomfortable for the wearer.

Dipped: All products in the coated range are seamless knitted liners which are dipped on a hand mould into a polymer solution. The polymer used will affect the level of abrasion, cut and puncture resistance the glove offers.

Cut and Sewn: All products in the leather range are constructed in this way. Generally these are made from either a Keystone or Wing thumb cut pattern.

Sleeve Styles



Knitted Sleeves

Manufactured using Rhino proprietary yarn technology in a seamless fitted design with or without a thumb slot.



Woven Sleeves

Lightweight and breathable and provides contact heat protection. Styles can be available with optional fastenings and thumb slot.



Rhinoguard™ Sleeves

Constructed using our unique Rhinoguard™ fabric the sleeve is designed to provide flexibility and ease of movement and can be wiped clean to extend its usable life.



A worker in a factory setting is shown from the side, wearing safety glasses and a light-colored shirt. They are wearing dark, textured gloves and holding a large, dark, cylindrical metal component. The background is a dimly lit industrial environment with metal shelving and equipment. The overall lighting is low, with a blueish tint, emphasizing the industrial and safety theme.

Lightweight coated cut resistant gloves

Lightweight coated gloves deliver grip, comfort and dexterity combined with high level mechanical protection and durability.

COMING IN 2019

Experience the incredible fine touch dexterity of an 18 gauge glove

58-4110

Ultra-lightweight 18 gauge cut level D PU palm coated glove

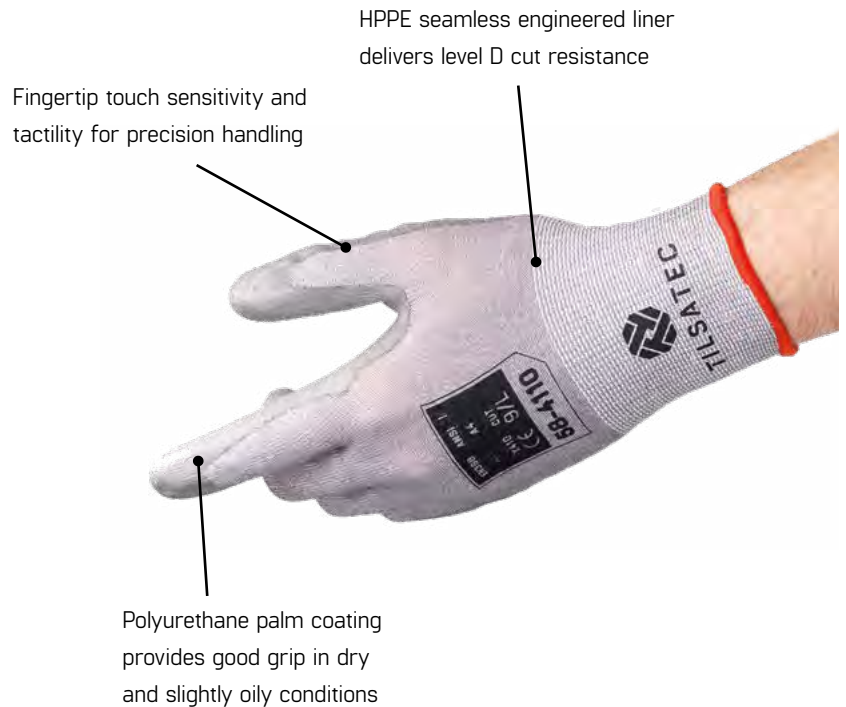

Features & Benefits

- Ultra fine 18 gauge lightweight liner
- EN388:2016 level D cut resistance
- Rhino Yarn™ cut resistant technology
- Exceptional level of fingertip sensitivity and tactility
- Dark colour liner hides dirt, extending life of the glove
- Seamless liner and cuff gives a smooth, comfortable feel

Applications / Industries



- Final fix / light assembly
- Automotive assembly
- Light metal fabrication / stamping / press
- Aerospace
- Construction
- White goods manufacturing

Performance

EN388: 2016

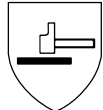

3 X 4 1 D



Antistatic according to the requirements of EN 1149-5: 2008 using EN 1149-3: 2004 induction charging test method.



Code	Description	Gauge	Colour	Cuff Style	Length	Sizes	Packaging
58-4110	Ultra-lightweight 18 gauge cut level D PU palm coated glove	18gg	Grey liner Grey coating	Knit wrist	230-270mm	7/S - 11/2XL	12 pairs/polybag 120 pairs/carton

combined with level D cut protection

58-4120

Ultra-lightweight 18 gauge cut level D
foam flex nitrile palm coated glove

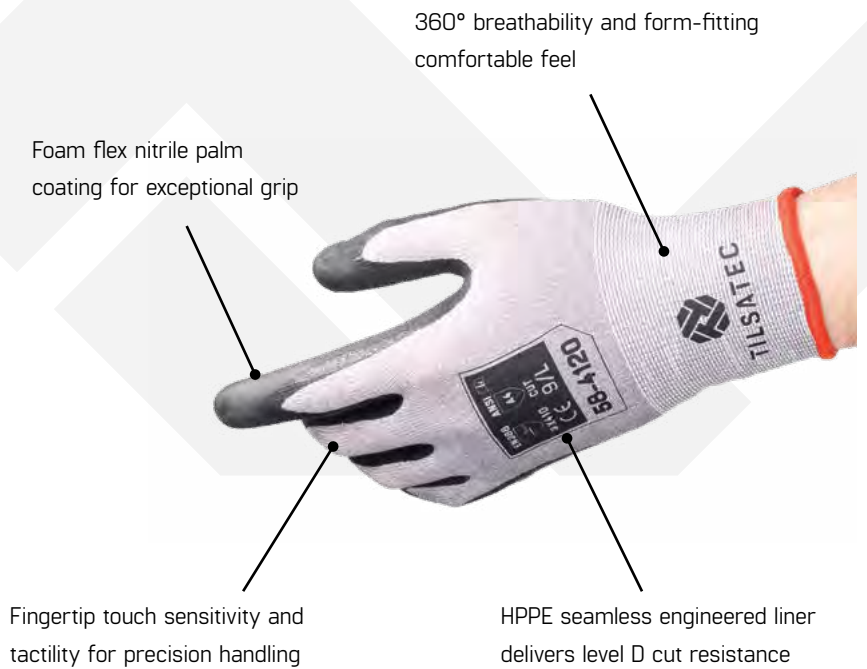

Features & Benefits

- Ultra fine 18 gauge lightweight liner
- EN388:2016 level D cut resistance
- Rhino Yarn™ cut resistant technology
- Exceptional level of fingertip sensitivity and tactility
- Breathable liner and palm coating keeps hands cool and dry
- Foam nitrile flex palm delivers good dry and oil grip
- Dark colour liner hides dirt, extending life of the glove
- Seamless liner and cuff gives a smooth, comfortable feel
- Coating is non-marking on soft coat glass

Applications / Industries



- Final fix / light assembly
- Automotive assembly
- Light metal fabrication / stamping / press
- Aerospace
- Construction
- White goods manufacturing

Performance

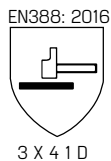

Antistatic according to the requirements of EN 1149-5: 2008
using EN 1149-3: 2004 induction charging test method.



Code	Description	Gauge	Colour	Cuff Style	Length	Sizes	Packaging
58-4120	Ultra-lightweight 18 gauge cut level D foam flex nitrile palm coated glove	18gg	Grey liner Black coating	Knit wrist	230-270mm	7/S - 11/2XL	12 pairs/polybag 120 pairs/carton

58-5420

18gg Kevlar® ultra-lightweight
foam nitrile palm coated glove

Features & Benefits

- EN388: 2016 level E cut resistance
- 18 gauge lightweight Kevlar® liner
- Dupont™ Kevlar® Innovation Award winner 2016
- Second skin feel and dexterity
- Good dry grip and oil grip
- Breathable open back and palm
- Ergonomic form fitting seamless liner

Applications / Industries



- Assembly
- Automotive industry
- Glass manufacturing
- Metal fabrication / stamping
- Construction
- Aerospace

Performance

EN388: 2016

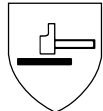

1 X 4 2 E



Antistatic according to the requirements of EN 1149-5: 2008
using EN 1149-3: 2004 induction charging test method.



MADE WITH

MADE WITH
Kevlar
GENUINE

Code	Description	Gauge	Colour	Cuff Style	Length	Sizes	Packaging
58-5420	18 gauge Kevlar® ultra-lightweight foam nitrile palm coated glove	18gg	Yellow liner Black coating	Knit wrist	230-270mm	7/S - 11/2XL	12 pairs/polybag 108 pairs/carton

55-5123

Lightweight cut resistant fully coated nitrile
glove with micropore foam palm

Features & Benefits

- EN388: 2016 level E cut resistance
- Rhino Yarn™ cut resistant technology
- Fine 15 gauge lightweight liner
- High level of tactility and dexterity
- Micropore foam nitrile palm delivers good dry and oil grip
- Flat nitrile full dip provides oil repellency and liquid protection keeping hands dry and comfortable

Applications / Industries



- Assembly
- Automotive industry
- Glass manufacturing
- Metal fabrication / stamping
- Transportation
- White goods manufacturing

Performance

EN388: 2016

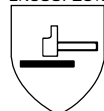

3 X 4 3 E



Antistatic according to the requirements of EN 1149-5 : 2008
using EN 1149-3 : 2004 induction charging test method.



RHINOYARN

Code	Description	Gauge	Colour	Cuff Style	Length	Sizes	Packaging
55-5123	Lightweight cut resistant fully coated nitrile glove with micropore foam palm	15gg	Black liner Black coating	Knit wrist	230-270mm	7/S - 11/2XL	12 pairs/polybag 120 pairs/carton

55-5120

Lightweight cut resistant micropore foam nitrile palm coated glove

Features & Benefits

- EN388: 2016 level E cut resistance
- Rhino Yarn™ cut resistant technology
- Fine 15 gauge lightweight liner
- High level of tactility and dexterity
- Breathable liner and palm coating
- Micropore foam nitrile palm delivers good dry and oil grip

Applications / Industries



- Final fix / light assembly
- Automotive assembly
- Light metal fabrication / stamping / press
- Aerospace
- Construction
- White goods manufacturing

Performance

EN388: 2016

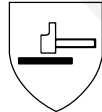

3 X 4 3 E



Antistatic according to the requirements of EN 1149-5: 2008 using EN 1149-3: 2004 induction charging test method.



Code	Description	Gauge	Colour	Cuff Style	Length	Sizes	Packaging
55-5120	Lightweight cut resistant micropore foam nitrile palm coated glove	15gg	Black liner Black coating	Knit wrist	230-270mm	7/S - 11/2XL	12 pairs/polybag 120 pairs/carton

55-5110

Lightweight cut resistant PU palm coated glove

Features & Benefits

- EN388: 2016 level E cut resistance
- Rhino Yarn™ cut resistant technology
- Fine 15 gauge lightweight liner
- High level of tactility and dexterity
- Durable PU palm coating provides secure dry grip and light oil grip
- Dark colour hides dirt, extending life of the glove
- Seamless liner and cuff gives a smooth, comfortable feel

Applications / Industries



- Assembly
- Automotive industry
- Metal fabrication / stamping
- Glass manufacturing
- Transportation
- Construction
- White goods manufacturing

Performance

EN388: 2016

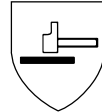

3 X 4 3 E



Antistatic according to the requirements of EN 1149-5: 2008 using EN 1149-3: 2004 induction charging test method.



Code	Description	Gauge	Colour	Cuff Style	Length	Sizes	Packaging
55-5110	Lightweight cut resistant PU palm coated glove	15gg	Black liner Grey coating	Knit wrist	220-270mm	7/S - 11/2XL	12 pairs/polybag 120 pairs/carton





Medium weight coated cut resistant gloves

Medium weight hard wearing hand protection delivering level E cut protection, durability and grip

EN388
4X42E
CE 10/XL
ANSI
A5
01-5111

50-5121

Medium weight cut resistant foam nitrile palm coated glove with thumb reinforcement

Features & Benefits

- EN388: 2016 level E cut resistance
- Rhino Yarn™ cut resistant technology
- High level of abrasion resistance
- EN407 contact heat level 1
- Secure grip, particularly in dry and oily conditions
- Breathable open back and coating reduces perspiration
- Dark colour hides dirt, extending life of the glove
- Thumb crotch is reinforced for additional durability and resilience

Applications / Industries



- Assembly
- Automotive industry
- Metal fabrication / stamping
- Glass manufacturing
- Transportation
- Construction
- White goods manufacturing

Performance

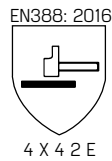

4 X 4 2 E



X 1 X X X X



Code	Description	Gauge	Colour	Cuff Style	Length	Sizes	Packaging
50-5121	Medium weight cut resistant foam nitrile palm coated glove w/thumb reinforcement	10gg	Black liner Black coating	Knit wrist	230-270mm	7/S - 11/2XL	12 pairs/polybag 120 pairs/carton

50-5111

Medium weight cut resistant PU palm coated glove with thumb reinforcement

Features & Benefits

- EN388: 2016 level E cut resistance
- Rhino Yarn™ cut resistant technology
- High level of abrasion resistance
- PU Palm coating provides secure dry and light oil grip
- Dark colour hides dirt, extending life of the glove
- Seamless liner and cuff gives a smooth, comfortable feel
- Thumb crotch is reinforced for additional durability and resilience

Applications / Industries



- Assembly
- Automotive industry
- Glass manufacturing
- Metal fabrication / stamping
- Construction
- White goods manufacturing

Performance

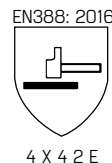

4 X 4 2 E



Code	Description	Gauge	Colour	Cuff Style	Length	Sizes	Packaging
50-5111	Medium weight cut resistant PU palm coated glove w/thumb reinforcement	10gg	Black liner Grey coating	Knit wrist	220-270mm	6/XS - 11/2XL	12 pairs/polybag 120 pairs/carton

50-5130

Medium weight cut resistant latex palm coated glove

Features & Benefits

- EN388: 2016 level E cut resistance
- Rhino Yarn™ cut resistant technology
- High level of abrasion resistance
- Level 3 puncture resistance
- Crinkle latex palm coating delivers excellent dry and wet grip
- Dark colour hides dirt, extending life of the glove
- Seamless liner and cuff gives a smooth, comfortable feel

Applications / Industries



- Glass manufacturing
- Metal fabrication / stamping
- Waste handling
- Recycling
- Construction
- White goods manufacturing

Performance

EN388: 2016

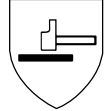

3 X 4 3 E



Code	Description	Gauge	Colour	Cuff Style	Length	Sizes	Packaging
50-5130	Medium weight cut resistant latex palm coated glove	10gg	Black liner Black coating	Knit wrist	230-270mm	7/S - 11/2XL	12 pairs/polybag 120 pairs/carton

030PU

Cut resistant PU palm coated glove

Features & Benefits

- EN388:2003 level 4 cut resistance
- Rhino Yarn™ cut resistant technology
- Good abrasion resistance
- PU palm coating provides secure dry grip and light oil grip
- Lightweight, soft and comfortable against the skin allowing for long periods of wear



Applications / Industries



- Assembly
- Automotive industry
- Metal fabrication / stamping
- White goods manufacturing
- Construction

Performance

EN388: 2003

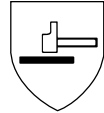

3 4 4 2



Code	Description	Gauge	Colour	Cuff Style	Length	Sizes	Packaging
030PU	Cut resistant PU palm coated glove	10gg	White liner Grey coating	Knit wrist	220-270mm	6/XS - 11/2XL	12 pairs/polybag 96 pairs/carton

53-5420

Medium weight cut resistant foam nitrile palm coated glove

Features & Benefits

- EN388:2003 level 5 cut resistance
- Rhino Yarn™ cut resistant technology
- Excellent dry and oil grip
- Palm coating repels oil and liquids
- Highly breathable liner and coating
- EN407 contact heat level 1

Applications / Industries



- Assembly
- Automotive industry
- Metal fabrication / stamping
- Glass manufacturing
- Transportation
- Construction
- White goods manufacturing

Performance

EN388: 2003

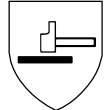

4 5 4 2

EN407: 2004



X 1 X X X X



Antistatic according to the requirements of EN 1149-5: 2008 using EN 1149-3: 2004 induction charging test method.



Code	Description	Gauge	Colour	Cuff Style	Length	Sizes	Packaging
53-5420	Medium weight cut resistant foam nitrile palm coated glove	13gg	Green liner Black coating	Knit wrist	230-270mm	7/S - 11/2XL	12 pairs/polybag 108 pairs/carton

33-5620

Medium weight cut resistant liner glove

Features & Benefits

- EN388:2003 level 5 cut resistance
- Rhino Yarn™ cut resistant technology
- High comfort and dexterity
- Ideal as an under glove with a disposable over
- Available with a dot pattern to the palm for enhanced grip
- Antistatic to EN1149-5: 2008



Applications / Industries



- Light assembly
- Metal fabrication
- Aerospace
- White goods manufacturing
- Logistics

Performance

EN388: 2003

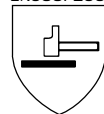

2 5 4 X

EN407: 2004



X 1 X X X X



Antistatic according to the requirements of EN 1149-5: 2008 using EN 1149-3: 2004 induction charging test method.



Code	Description	Gauge	Colour	Cuff Style	Length	Sizes	Packaging
33-5620	Medium duty cut resistant liner glove	13gg	Green liner	Knit wrist	230-270mm	7/S - 11/2XL	12 pairs/polybag 108 pairs/carton

33-5610

Medium weight cut resistant dotted grip glove

Features & Benefits

- EN388:2003 level 5 cut resistance
- Rhino Yarn™ cut resistant technology
- High comfort and dexterity
- Dot pattern to palm provides additional grip
- Antistatic to EN1149-5: 2008



Applications / Industries



- Light assembly
- Metal fabrication
- Aerospace
- White goods manufacturing
- Logistics

Performance

EN388: 2003

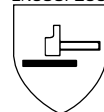

2 5 4 X

EN407: 2004



X 1 X X X X



Antistatic according to the requirements of EN 1149-5: 2008 using EN 1149-3: 2004 induction charging test method.



Code	Description	Gauge	Colour	Cuff Style	Length	Sizes	Packaging
33-5610	Medium weight cut resistant pvc dot grip glove	13gg	Green liner	Knit wrist	230-270mm	7/S - 11/2XL	12 pairs/polybag 108 pairs/carton

RHINO GUARD™ Cut Puncture and Needlestick Protection

RHINO GUARD™ is a highly engineered textile composite primarily designed to provide the highest levels of protection against a wide range of puncture hazards. The material is constructed from an innovative combination of advanced fibres, modified fabric structure and a unique coating technology to deliver high levels of protection against both large and small puncture threats (including needles and syringes). Uniquely for a puncture resistant material, RHINO GUARD™ also provides protection against cuts, heat and flame, abrasion and liquids. All of this is achieved in a lightweight, thin and flexible material which can be employed in a range of demanding environments.

49-5410

Rhinoguard™ arm guard

The 9" arm guard provides cut, puncture and needlestick protection in a simple yet effective arm guard. With robust fastening strips the sleeve stays firmly in place when in use, can be adjusted for a secure fit and allows for quick and easy removal.



49-5411

Rhinoguard™ sleeve

The 19" sleeve provides all the performance of RHINO GUARD™ in a full length sleeve protecting the wrist, forearm, elbow and bicep areas for handling materials which offer potential cut and puncture hazards. A series of pleats to the elbow area means no restriction of movement and a thumb slot ensures a secure fit. As the RHINO GUARD™ fabric provides liquid protection the sleeve is ideal for glass handling, metal forming, waste management and recycling.



Features & Benefits

- EN388:2003 level 5 cut resistance (level E cut resistance under EN388: 2016. Certification in progress)
- Rhino Yarn™ cut resistant technology
- EN388 level 4 puncture resistance
- ASTM F2878-10 hypodermic needle test: 5.7 Newtons
- Arm guard has 2 straps for an adjustable fit
- Liquid protection
- The fire resistant properties of RHINO GUARD™ will not diminish with multiple laundering cycles
- RHINO GUARD™ fabric is stable in exposure to temperatures of up to 200°f

Applications / Industries



- Emergency services:
- Police, Fire Fighters, Search and Rescue.
- Security services
- Local authorities, house clearance teams
- Waste management
- Metal forming / handling

Performance

EN388: 2003

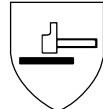

4 5 4 4



Code	Description	Gauge	Colour	Cuff Style	Length	Sizes	Packaging
49-5410	Rhinoguard™ arm guard	N/A	Grey	N/A	9"	one size	Packed per piece 10 pieces/carton
49-5411	Rhinoguard™ 19" sleeve	N/A	Grey	N/A	19"	one size	Packed per piece 10 pieces/carton

49-6220

Mechanics glove with Rhinoguard™

The RHINO GUARD™ mechanics glove delivers cut, abrasion, puncture and needle resistance in a powerful combination of mechanical protection for extreme working conditions. The areas of the glove with RHINO GUARD™ inside include the palm, fingers, finger crotches and fingertips to ensure the most exposed regions to hazards have full protection coverage.

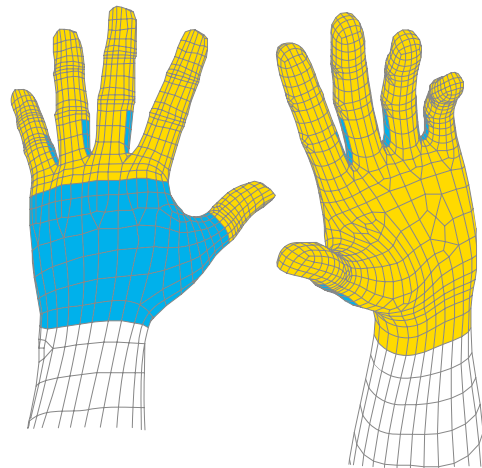

- Level 5 cut resistance + Rhinoguard™ cut, puncture and needlestick protection
- Level 5 cut resistance

Features & Benefits

- EN388:2003 level 5 cut resistance (level E cut resistance under EN388: 2016. Certification in progress)
- Rhino Yarn™ cut resistant technology
- EN388 level 4 puncture resistance
- ASTM F2878-10 hypodermic needle test: 5.7 Newtons
- Leather reinforcement for high action areas
- Rubber pull tab for quick donning and doffing
- Neoprene expandable wrist for safety and comfort

Applications / Industries



- Emergency services:
- Police, Fire Fighters, Search and Rescue.
- Security services
- Local authorities, house clearance teams
- Waste management
- Metal forming / handling

Performance

EN388: 2003

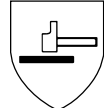

4 5 4 4



Code	Description	Gauge	Colour	Cuff Style	Length	Sizes	Packaging
49-6220	Mechanics glove with Rhinoguard™	N/A	Grey	Neoprene	230 - 270mm	8/M - 11/2XL	Packed per pair 36 pairs/carton

FOOD-SAFE Cut Resistant Gloves

The Tilsatec range of antimicrobial, cut resistant food gloves are designed specifically for the food industry. Fully launderable, the antimicrobial properties are engineered to last the lifetime of the gloves and there is a weight and style to suit most food preparation applications where cut resistance is required.



405B

Lightweight antimicrobial cut resistant food glove

Features & Benefits

- Rhino Yarn™ cut resistant technology
- EN388:2003 level 5 cut resistance (level E cut resistance under EN388: 2016. Certification in progress)
- Permanent antimicrobial component
- May be washed at up to 92°C
- Colour coded to prevent cross contamination
- Extended cuff for added protection
- Designed for knife hand use
- Ambidextrous



Applications / Industries



- Vegetable preparation
- Food packaging and processing
- Light duty meat carving and slicing
- Butchery

Performance

EN388: 2003

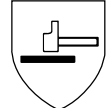

2 5 4 X

EN407: 2004



X 1 X X X X



Antistatic according to the requirements of EN 1149-5: 2008 using EN 1149-3: 2004 induction charging test method.



Tilsatec antimicrobial food gloves do not contain any glass materials which may fibrillate and break off when in contact with food stuffs. Gloves are suitable for contact with all food stuffs in compliance with EC Regulation 1935/2004.

Code	Description	Gauge	Colour	Cuff Style	Length	Sizes	Packaging
405B	Lightweight antimicrobial cut resistant food glove	10gg	Blue	Knit wrist	255-305mm	6/XS - 11/2XL	6 pieces/polybag 216 pieces/carton

407B

Medium weight antimicrobial cut resistant food glove

Features & Benefits

- Rhino Yarn™ cut resistant technology
- EN388:2003 level 5 cut resistance (level F cut resistance under EN388: 2016. Certification in progress)
- Permanent antimicrobial component
- May be washed at up to 92°C
- Colour coded to prevent cross contamination
- Extended cuff for added protection
- Designed for knife hand use
- Ambidextrous



Applications / Industries



- Meat carving and deboning
- Butchery
- Fish filleting and processing
- Suitable for beef, pork and poultry

Performance

EN388: 2003

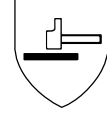

4 5 4 X

EN407: 2004



X 1 X X X X



Antistatic according to the requirements of EN 1149-5: 2008 using EN 1149-3: 2004 induction charging test method.



Code	Description	Gauge	Colour	Cuff Style	Length	Sizes	Packaging
407B	Medium weight antimicrobial cut resistant food glove	10gg	Blue	Knit wrist	255-305mm	6/XS - 11/2XL	6 pieces/polybag 144 pieces/carton

410B

Heavyweight antimicrobial cut resistant food glove

Features & Benefits

- Rhino Yarn™ cut resistant technology
- EN388:2003 level 5 cut resistance (level F cut resistance under EN388: 2016. Certification in progress)
- Permanent antimicrobial component
- May be washed at up to 92°C
- Colour coded to prevent cross contamination
- Extended cuff for added protection
- Designed for knife hand use
- Ambidextrous



Applications / Industries



- Meat carving and deboning
- Butchery
- Suitable for beef, pork and poultry

Performance

EN388: 2003

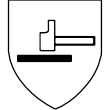

2 5 4 X

EN407: 2004



X 1 X X X X



Antistatic according to the requirements of EN 1149-5: 2008 using EN 1149-3: 2004 induction charging test method.



Tilsatec antimicrobial food gloves do not contain any glass materials which may fibrillate and break off when in contact with food stuffs. Gloves are suitable for contact with all food stuffs in compliance with EC Regulation 1935/2004.

Code	Description	Gauge	Colour	Cuff Style	Length	Sizes	Packaging
410B	Heavyweight antimicrobial cut resistant food glove	7gg	Blue	Knit wrist	255-305mm	6/XS - 11/2XL	6 pieces/polybag 144 pieces/carton

KNITTED / LEATHER Cut Resistant Gloves

Our range of knitted and leather gloves offer a number of weights and styles, leather configurations and palm coverings to provide enhanced abrasion resistance, heat protection and puncture protection.



088

Antistatic lint free glove

Features & Benefits

- Permanent ESD protection to EN1149-1 with a mean resistance of $3.4 \Omega \times 10^3$
- Extended 15cm cuff for added protection
- Silicone free
- Manufactured from continuous filament materials to minimise lint
- May be laundered at 60°C and tumble dried to maximise service life
- Ambidextrous



Applications / Industries



- Pre and post painting areas
- Electronic manufacturing

Performance

EN388: 2003

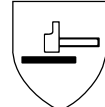

2 1 4 2



Antistatic according to the requirements of EN 1149-5: 2008 using EN 1149-3: 2004 induction charging test method.

Code	Description	Gauge	Colour	Cuff Style	Length	Sizes	Packaging
088	Antistatic lint free glove	13gg	White/Grey mix	Knit wrist	330mm	9/L	12 pairs/polybag 288 pairs/carton

11-3328

Hot end gauntlet glove

Features & Benefits

- EN407 contact heat level 2
- Rhino Yarn™ cut resistant technology
- EN388:2003 level 3 cut resistance
- Loop pile knitted glove section for improved thermal protection and cushioning from repeated handling
- Extended gauntlet style cuff provides forearm protection
- Black colour hides dirt, extending life of the glove
- Ambidextrous



Applications / Industries



- Glass manufacturing
- Hot end operations
- High heat areas requiring some mechanical protection
- Bakeries

Performance

EN388: 2003

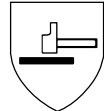

2 3 2 2

EN407: 2004



X 2 X X X X



Code	Description	Gauge	Colour	Cuff Style	Length	Sizes	Packaging
11-3328	Hot end gauntlet glove	7gg	Black glove Black cuff	Canvas gauntlet	420-440mm	8/M - 10/XL	12 pairs/polybag 36 pairs/carton

37-5622

Medium duty cut resistant 'loop out' glove with thumb reinforcement

Features & Benefits

- Rhino Yarn™ cut resistant technology
- EN388:2003 level 5 cut resistance
- Loop out construction for extra comfort and durability
- Reinforced thumb crotch
- Ambidextrous



Applications / Industries



- Assembly
- Automotive industry
- Metal fabrication / stamping

Performance

EN388: 2003

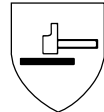

2 5 3 X



Code	Description	Gauge	Colour	Cuff Style	Length	Sizes	Packaging
37-5622	Medium duty cut resistant loop out glove with thumb reinforcement	7gg	Grey/Green	Knit wrist	220-260mm	6/XS - 10/XL	12 pairs/polybag 72 pairs/carton

37-5620

Medium duty cut resistant aramid knit glove

Features & Benefits

- EN388:2003 level 3 cut resistance
- Rhino Yarn™ cut resistant technology
- Good level of abrasion resistance
- Durable and long lasting
- EN407 burning behaviour level 4
- EN407 contact heat level 2 protection
- Reinforced thumb crotch for high action areas
- Can be repeat laundered extending product life

Applications / Industries



- Assembly
- Automotive industry
- Metal fabrication / stamping

Performance

EN388: 2003

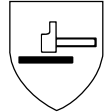

1 3 4 X

EN407: 2004



4 2 X X X X



Code	Description	Gauge	Colour	Cuff Style	Length	Sizes	Packaging
37-5620	Medium duty cut resistant aramid knit glove	7gg	Yellow	Knit wrist	240-260mm	8/M - 10/XL	12 pairs/polybag 96 pairs/carton

37-4523

Heavy duty cut resistant aramid knit glove

Features & Benefits

- EN388:2003 level 4 cut resistance
- Rhino Yarn™ cut resistant technology
- Durable and long lasting
- EN407 burning behaviour level 4
- EN407 contact heat level 1 protection
- Reinforced thumb crotch for high action areas
- Can be repeat laundered extending product life

Applications / Industries



- Assembly
- Automotive industry
- Metal fabrication / stamping

Performance

EN388: 2003

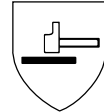

1 4 4 X

EN407: 2004



4 1 X X X X



Code	Description	Gauge	Colour	Cuff Style	Length	Sizes	Packaging
37-4523	Heavy duty cut resistant aramid knit glove	7gg	Yellow	Knit wrist	240-260mm	7/S - 11/2XL	12 pairs/polybag 96 pairs/carton

37-4528

X-Heavy duty cut resistant aramid knit glove

Features & Benefits

- EN388:2003 level 4 cut resistance
- Rhino Yarn™ cut resistant technology
- Durable and long lasting
- EN407 burning behaviour level 4
- EN407 contact heat level 1 protection
- Reinforced thumb crotch for high action areas
- Can be repeat laundered extending product life

Applications / Industries



- Assembly
- Automotive industry
- Metal fabrication / stamping

Performance

EN388: 2003

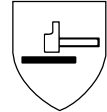

1 4 4 X

EN407: 2004



4 1 X X X X



Code	Description	Gauge	Colour	Cuff Style	Length	Sizes	Packaging
37-4528	X-Heavy duty cut resistant aramid knit glove	7gg	Yellow	Knit wrist	240-270mm	8/M - 11/2XL	12 pairs/polybag 96 pairs/carton

84-3106

6" cut resistant aramid knit cuff

Features & Benefits

- EN388:2003 level 3 cut resistance
- Rhino Yarn™ cut resistant technology
- Good level of abrasion resistance
- Durable and long lasting
- EN407 burning behaviour level 4
- EN407 contact heat level 2 protection
- Can be repeat laundered extending product life

Applications / Industries



- Assembly
- Automotive industry
- Metal fabrication / stamping

Performance

EN388: 2003

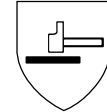

1 3 4 X

EN407: 2004



4 2 X X X X



Code	Description	Gauge	Colour	Cuff Style	Length	Sizes	Packaging
84-3106	6" cut resistant aramid cuff	7gg	Yellow	Knit wrist	6"	one size	Packed per piece 216 pieces/carton

37-6620

Medium duty cut resistant glove

Features & Benefits

- EN388:2003 level 5 cut resistance
- Rhino Yarn™ cut resistant technology
- Soft, comfortable seamless liner with good dexterity
- Reinforced thumb crotch for high action area
- Suitable for industrial laundering to extend product life
- Also available with a pvc dot pattern to the palm for enhanced grip
- Antistatic to EN1149-5: 2008



Applications / Industries



- Assembly
- Metal fabrication
- Glass industry
- Logistics

Performance

EN388: 2003

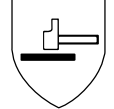

2 5 4 X

EN407: 2004



X 1 X X X X



Antistatic according to the requirements of EN 1149-5 : 2008 using EN 1149-3 : 2004 induction charging test method.



Code	Description	Gauge	Colour	Cuff Style	Length	Sizes	Packaging
37-6620	Medium duty cut resistant glove	7gg	Yellow/grey liner	Knit wrist	230-260mm	8/M - 10/XL	12 pairs/polybag 96 pairs/carton

204

Medium duty FR backed cut resistant leather glove

Features & Benefits

- EN388:2003 level 5 cut resistance
- Rhino Yarn™ cut resistant technology
- EN407 contact heat level 1
- EN388 Level 3 puncture resistance
- Leather palm provides oil resistance and good grip
- Flame resistant fabric provides protection from weld spatter to the back of the hand



Applications / Industries



- Assembly
- Automotive industry
- Metal fabrication / stamping
- Oil & Gas
- Utilities

Performance

EN388: 2003

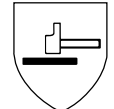

4 5 4 3

EN407: 2004



X 1 X X X X



Antistatic according to the requirements of EN 1149-5 : 2008 using EN 1149-3 : 2004 induction charging test method.



Code	Description	Gauge	Colour	Cuff Style	Length	Sizes	Packaging
204	Medium duty FR backed cut resistant leather glove	7gg	Yellow fabric Grey palm	Knit wrist	230-270mm	7/S - 11/2XL	12 pairs/polybag 72 pairs/carton

37-5630

Medium duty cut resistant leather palm glove



Features & Benefits

- EN388:2003 level 5 cut resistance
- Rhino Yarn™ cut resistant technology
- EN388 level 4 abrasion resistance
- EN388 Level 3 puncture resistance
- Leather palm suitable for oily and dry handling
- Enhanced protection to finger tips from extended leather palm
- Reinforced thumb crotch

Applications / Industries



- Assembly
- Automotive industry
- Metal fabrication / stamping
- Glass industry

Performance

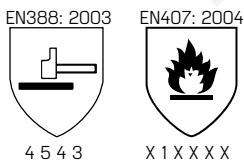

Antistatic according to the requirements of EN 1149-5 : 2008 using EN 1149-3 : 2004 induction charging test method.



Code	Description	Gauge	Colour	Cuff Style	Length	Sizes	Packaging
37-5630	Medium duty cut resistant leather palm glove	7gg	Grey liner Grey palm	Knit wrist	225-270mm	7/S - 11/2XL	12 pairs/polybag 72 pairs/carton

33-5631

Light weight FR backed cut resistant leather glove



Features & Benefits

- EN388:2003 level 5 cut resistance
- Rhino Yarn™ cut resistant technology
- EN407 contact heat level 1
- EN388 Level 3 puncture resistance
- Leather palm provides oil resistance and good grip
- Flame resistant fabric provides protection from weld spatter to the back of the hand

Applications / Industries



- Assembly
- Automotive industry
- Metal fabrication / stamping
- Oil & Gas
- Utilities

Performance

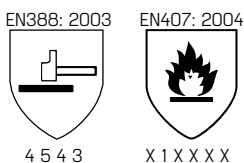

Antistatic according to the requirements of EN 1149-5 : 2008 using EN 1149-3 : 2004 induction charging test method.



Code	Description	Gauge	Colour	Cuff Style	Length	Sizes	Packaging
33-5631	Lightweight FR backed cut resistant leather glove	13gg	Black fabric Grey palm	Knit wrist	230-270mm	7/S - 11/2XL	12 pairs/polybag 72 pairs/carton

Arm & Body Protection

Many industrial applications such as metal stamping and glass handling require additional protection to the wrist, arm and torso. The Tilsatec range incorporates solutions in various lengths and styles to protect all of these areas.

001

Seamless knitted cut resistant sweatshirt



The 001 sweatshirt is a highly cut resistant garment designed to protect workers in industries such as glass manufacturing, metal fabrication, automotive manufacturing and waste recycling.

The advanced garment design is developed using the latest in cutting edge technology and manufacturing techniques. Soft and lightweight, the fabric has a 'cool to the touch feel' and the inclusion of under arm vents ensures maximum wearer comfort. Fully washable at up to 60°C with no impairment to the cut resistant properties.

Features & Benefits

- EN388:2003 level 5 cut resistance
- Rhino Yarn™ cut resistant technology
- Seamless knitted construction for ease of movement
- Full body protection covering major arteries and key vulnerable areas
- Cool touch, lightweight fabric provides maximum user comfort
- High neck design allows safe handling of sheet materials
- Underarm vents for enhanced breathability
- Easy care - may be washed at up to 60°C and tumble dried

Size	To fit chest	Length
S	86CM / 34"	73CM
M	92CM / 36"	74CM
L	102CM / 40"	75CM
XL	112CM / 44"	75CM
2XL	122CM / 48"	76CM

Applications / Industries



- Glass industry
- Handling raw glass
- Cutting stations
- Automotive industry
- Metal fabrication / stamping

Performance

EN388: 2003

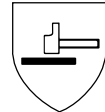

2 5 4 1



Code	Description	Gauge	Colour	Cuff Style	Length	Sizes	Packaging
001	Seamless knitted cut resistant sweatshirt	N/A	Grey	Knit wrist w/ thumb slot	See size chart	S - 2XL	Packed per piece

85-52

18" or 21" FR cut resistant sleeve with thumb slot

Features & Benefits

- EN388:2016 level F cut resistance
- Rhino Yarn™ cut resistant technology
- Inherently flame resistant
- Hook and loop top fastening strap for adjustable fit
- Thumb slot to keep sleeve in place
- Various finishes and fixings available on request



Applications / Industries



- Automotive industry
- Metal fabrication / stamping
- Manufacturing

Performance

EN388: 2016

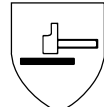

1 X 4 X F

EN407: 2004



2 1 X X X X



Code	Description	Gauge	Colour	Cuff Style	Length	Sizes	Packaging
85-5221	21" FR cut resistant sleeve with thumb slot	N/A	Green	Knit wrist w/ thumb slot	21"	one size	Packed per piece 100 pieces/carton
85-5218	18" FR cut resistant sleeve with thumb slot	N/A	Green	Knit wrist w/ thumb slot	18"	one size	Packed per piece 100 pieces/carton

84-3420

20" FR cut resistant sleeve

Features & Benefits

- EN388:2003 level 3 cut resistance
- Rhino Yarn™ cut resistant technology
- Lightweight and loose fitting
- Inherently flame resistant
- EN407 burning behaviour level 3
- Hook and loop top fastening strap for adjustable fit
- Thumb slot to keep sleeve in place
- Available with a liner for enhanced comfort



Applications / Industries



- Automotive industry
- Metal fabrication / stamping
- Manufacturing
- Aerospace

Performance

EN388: 2003

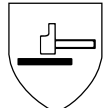

1 3 4 1

EN407: 2004



3 1 X X 2 X



Code	Description	Gauge	Colour	Cuff Style	Length	Sizes	Packaging
84-3420	20" FR cut resistant sleeve	N/A	Yellow	Knit wrist w/ thumb slot	20"	one size	Packed per piece 100 pieces/carton

85-5110

85-5114

85-5118

85-5121

10/14/18/21" cut resistant knitted sleeve
with thumb slot

The 85-51 family of seamless knitted tubular sleeves provide ISO 13997 level 5 cut protection. The smooth finish provides enhanced wearer comfort and ease of movement and a thumb slot keeps the sleeve firmly in place and an elasticated top prevents the sleeve from falling down the arm.



Features & Benefits

- EN388:2003 level 5 cut resistance
- Rhino Yarn™ cut resistant technology
- Seamless knit with a smooth finish
- Tubular close fitting shape for maximum dexterity
- Thumb slot to keep sleeve in place
- Various finishes and fixings available on request
- Elasticated top to prevent sleeve falling down

Applications / Industries



- Automotive industry
- Metal fabrication / stamping
- Manufacturing
- Glass industry
- Waste handling

Performance

EN388: 2003

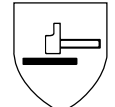

15 3 X

EN407: 2004



X 1 X X X X



Code	Description	Gauge	Colour	Cuff Style	Length	Sizes	Packaging
85-5110	10" cut resistant knitted sleeve with thumb slot	N/A	Green	Knit wrist w/ thumb slot	10"	one size	Packed per piece 100 pieces/carton
85-5114	14" cut resistant knitted sleeve with thumb slot	N/A	Green	Knit wrist w/ thumb slot	14"	one size	Packed per piece 100 pieces/carton
85-5118	18" cut resistant knitted sleeve with thumb slot	N/A	Green	Knit wrist w/ thumb slot	18"	one size	Packed per piece 100 pieces/carton
85-5121	21" cut resistant knitted sleeve with thumb slot	N/A	Green	Knit wrist w/ thumb slot	21"	one size	Packed per piece 100 pieces/carton

420B

Lightweight antimicrobial cut resistant food sleeve

Features & Benefits

- EN388:2003 level 5 cut resistance
- Permanent antimicrobial component
- Low linting to prevent product contamination
- May be washed at up to 92°C
- Designed for use with a Tilsatec food glove
- Thumb slot for a secure fit
- Elasticated top to keep sleeve in place



Applications / Industries



- Meat carving and deboning
- Butchery
- Suitable for beef, pork and poultry

Performance

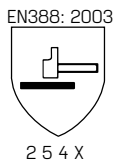

Antistatic according to the requirements of EN 1149-5 : 2008 using EN 1149-3 : 2004 induction charging test method.



Tilsatec antimicrobial food sleeves do not contain any glass materials which may fibrillate and break off when in contact with food stuffs. Sleeves are suitable for contact with all food stuffs in compliance with EC Regulation 1935/2004.

Code	Description	Gauge	Colour	Cuff Style	Length	Sizes	Packaging
420B	Lightweight antimicrobial cut resistant food sleeve	10gg	Blue	Knit wrist w/ thumb slot	20"	one size	Packed per piece 100 pieces/carton

89-5606

8" cut resistant wrist guard with adjustable straps

Features & Benefits

- EN388:2003 level 5 cut resistance
- Rhino Yarn™ cut resistant technology
- EN388 level 4 puncture resistance
- Protects the wrist and lower arm
- Adjustable sizing for accurate fit and wearer comfort
- Dark colour hides dirt
- Will not mark glass panels



Applications / Industries



- Glass industry
- Metal fabrication / stamping
- Manufacturing
- Waste management

Performance

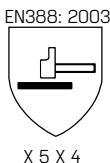

Code	Description	Gauge	Colour	Cuff Style	Length	Sizes	Packaging
89-5606	8" cut resistant wrist guard with adjustable straps	N/A	Black w/black straps	N/A	8"	one size	Packed per pair 10 pairs/carton



TILSATEC LIMITED
Flanshaw Lane, Wakefield
West Yorkshire, WF2 9ND
England

Tel: +44 1924 375742
Email: info@tilsatec.com
www.tilsatec.com